

# A Manual for Designing, Installing, and Maintaining Skimmer Sediment Basins

J. W. Faircloth & Son  
Post Office Box 757  
Hillsborough, North Carolina 27278  
Telephone/Fax (919) 732-1266

From [fairclothskimmer.com](http://fairclothskimmer.com), November 2005

## Introduction and Organization of Instructions

The following is a brief outline for use the skimmer, how to size and shape the basin, how to construct the basin and install the components, and how to maintain it. More detailed explanations and the reasoning behind the recommendations are included in the Appendix.

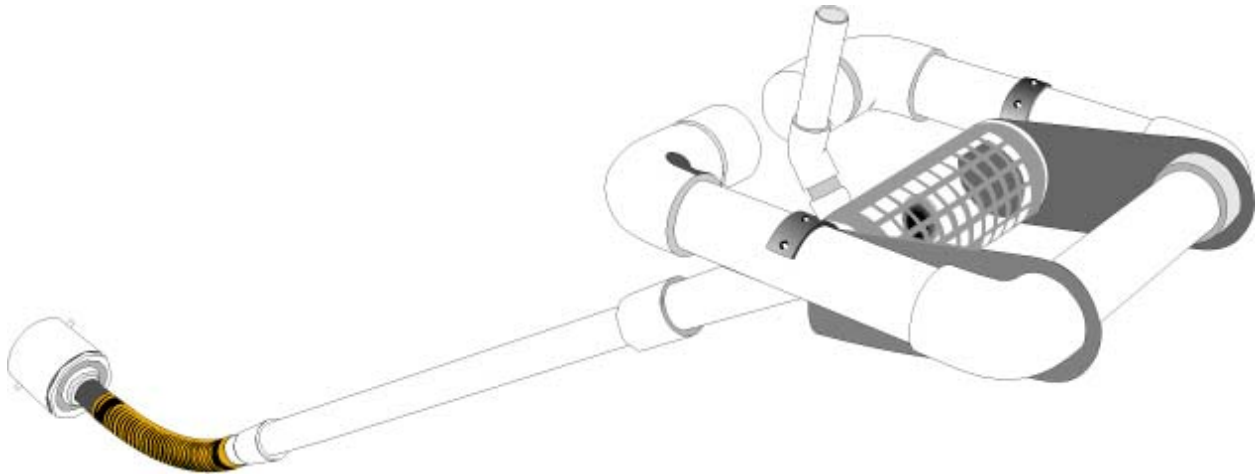

### Overview

The skimmer improves sediment trapping efficiency by regulating the filling and draining of the basin better than conventional methods using perforated risers or stone.

It works best on small basins **sized for the entire catchment**, less than half or three quarters of an acre (preferably less), because of the difficulty and expense of construction and maintenance, particularly sediment removal in large basins requiring equipment (usually a dragline) that can reach into a wide basin.

The skimmer orifice has a constant head that causes the basin to fill, creating conditions for gravity settling, and then drain slowly at a constant rate from near the surface.

If possible locate the basin outside a watercourse or stream to avoid disturbing the natural channel (and avoiding restabilization) and reduce the drainage area to the basin and therefore the size of the basin

### What the Skimmer Does

The skimmer utilizes the volume and surface area of the basin by regulating outflow from the basin so that it fills to create a pool of water that causes gravity settling.

Conventional basins with perforated risers or stone outlets frequently do not fill because the outlets structures do not adequately regulate the outflow; the skimmer makes the basin fill.

The skimmer drains the basin slowly over several days and at a constant rate to maximize settling.

Instead of draining the basin from the bottom, and releasing the most sediment concentrated runoff, the skimmer releases the least polluted water from near the surface.

For the skimmer to improve basin performance, the basin must be large enough. Many sediment basins, particularly those designed for a minimum volume per acre of disturbance instead of the total drainage area, are too small and need larger treatment and sediment storage volumes to be effective.

## **What the Skimmer DOES NOT DO**

The skimmer does not increase sediment trapping efficiency in a way that allows the size of the basin to be reduced.

Because of the increased trapping efficiency more sediment will be caught so more sediment storage volume is often needed.

The skimmer does not overcome poor performance caused by inadequate surface area and volume, improper shape, short circuiting, etc. that effect many sediment basins.

Where the soil type has a significant clay content the skimmer will not discharge clear outflow because of the difficulty capturing clay particles by gravity settling alone.

## **Important Considerations**

Each sediment basin design must consider the particular site conditions, soil type, drainage area, sediment generated, rainfall and runoff, damage potential downstream, etc. Sound engineering and construction practice and particularly common sense must be used in the design and construction of the basin. Design and construction must conform to appropriate local or State requirements, and in many cases exceed them to successfully control sediment pollution. It is advisable to request approval to use the skimmer in advance since it is an unconventional device.

Improving sediment trapping efficiency requires additional thought and time during design and construction. Therefore, skimmer basins may cost more. Experience is that the cost initially is usually slightly higher, but for some larger basins the cost may be less because the riser and barrel can be eliminated and a simpler spillway used for overflow. Some of the additional cost is because it is a different type of device than is normally used. Experience is that after building one or two skimmer basins it is easier and quicker for a grading contractor to build the next one.

It is important to build the skimmer basin correctly the first time. Rebuilding it or even making corrections after the basin has filled a few times is time consuming, and therefore expensive, and working in the mud is very unpleasant and, again, expensive.

# Plan View of Sediment Basin Components

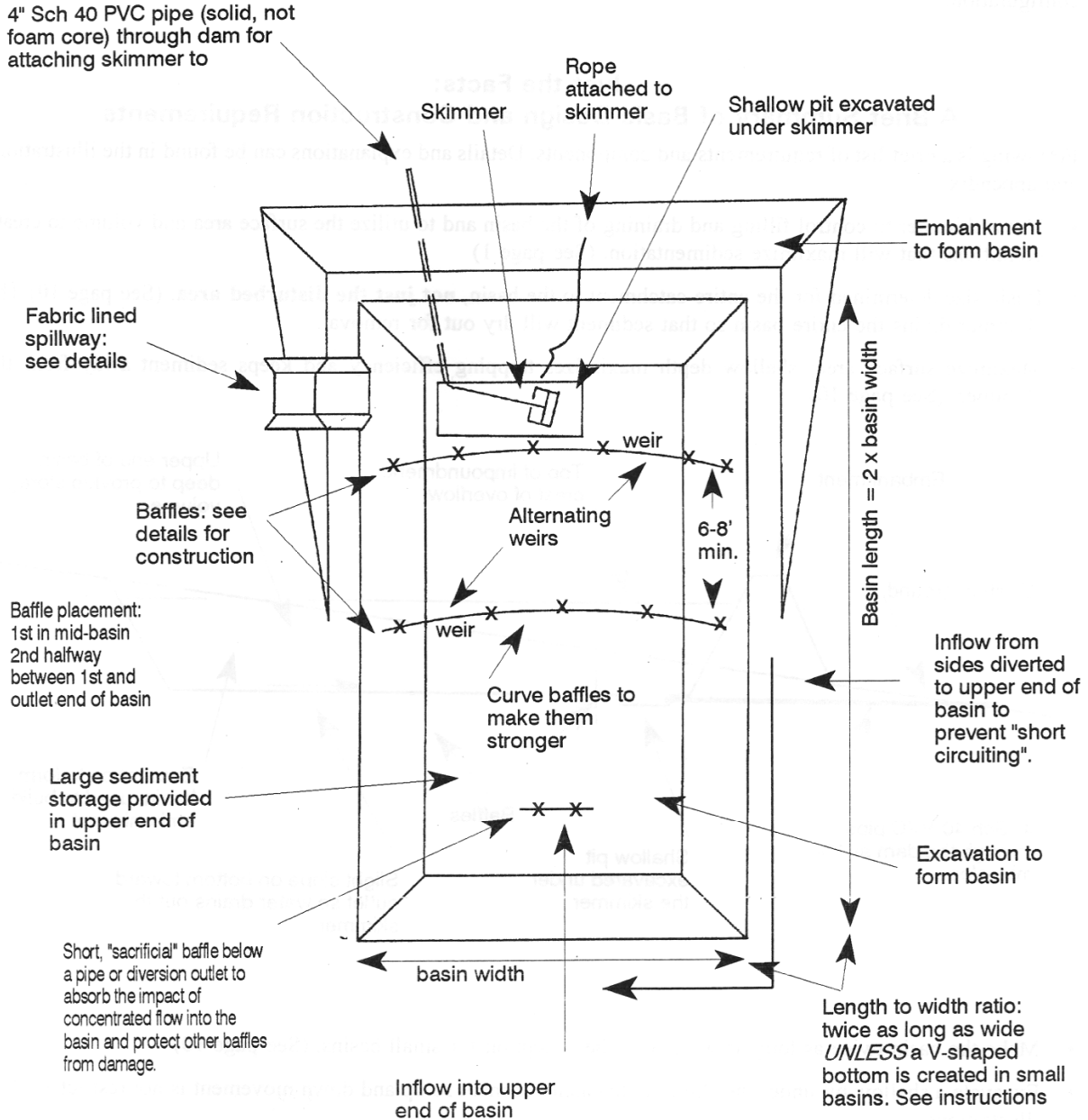

**NOTE ON SPILLWAY PLACEMENT:** Whenever possible place the spillway around one end of the dam instead of in the fill for the dam to minimize the chance of failure. Care must be taken when the spillway is in fill to follow the installation instructions and keep outflow on the fabric lining and off the erodible fill.

Some sediment basin requirements may conflict with permanent detention basin standards; if this is the case the features needed to create an effective sediment basin must be provided during construction. At the end of construction (when the drainage area is successfully stabilized) the basin is converted to the permanent configuration.

## Just the Facts: A Brief Summary of Basic Design and Construction Requirements

Following is a brief list of requirements and components. Details and explanations can be found in the illustrations and appendix.

Use a skimmer to control filling and draining of the basin and to utilize the surface area and volume to create conditions that will maximize sedimentation. (See page 1)

Basin size determined for the entire catchment to the basin, **not just the disturbed area**. (See page 10) The skimmer drains the entire basin so that sediment will dry out for removal.

Maximize surface area; shallow depth maximizes trapping efficiency and keeps sediment away from the skimmer. (See page 10)

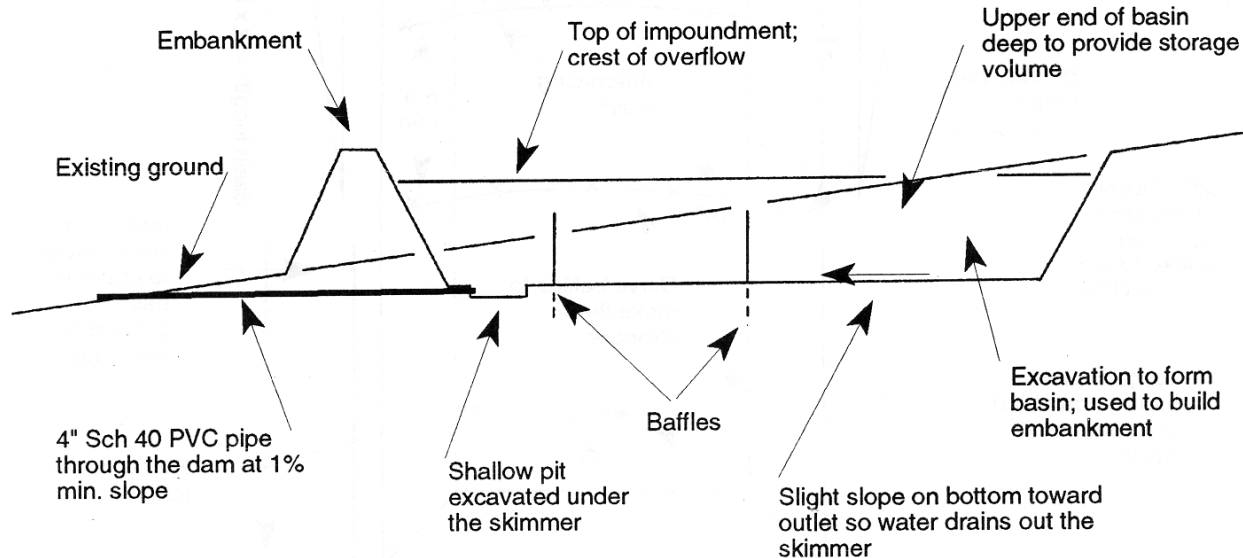

Make the basin twice as long as wide with the exception for small basins. (See page 10)

Excavate a shallow pit under the skimmer to catch sediment so up and down movement is not restricted. (See illustrations)

The skimmer must settle down level so that trash does not flow under the bottom edge of the float. (See page 11)

Outflow from the skimmer will still be turbid so dispersing the outflow into a wooded or vegetated buffer is recommended for additional treatment. (See page 11)

Provide positive drainage through the skimmer and the pipe through the dam so ice does not form and clog it. (See page 11)

Skimmer outlets: either a 4" Sch 40 pipe through the dam (where there is no riser) or a 4" Sch 40 connection on the riser. (See page 11)

Instead of a riser and barrel a spillway lined with fabric can be used in appropriate locations. (See page 11)

Baffles are necessary to keep sediment away from the skimmer and to limit resuspension of accumulated sediment; they are not optional. (See page 15)

Use common sense in baffle placement to allow sediment removal without damaging the baffles. (See page 15)

A minimum orifice diameter of 1/2" is recommended to avoid clogging. (See Page 6)

The skimmer cannot withstand being yanked around with a backhoe; use the rope to position the skimmer or pull it out of the way to excavate under it. (See page 7)

## Cutting and Installing the Orifice

The orifice must be sized for the volume of the basin it is installed in so it will drain within the desired time. A two day drawdown time is recommended but it can more or less. The basin volume can be obtained from the erosion and sediment control plan or estimated by measuring the dimensions and determining the surface area of the top (the high water elevation) and the bottom, averaging the two surface areas, then multiplying by the average depth.

Follow the instructions with the skimmer for determining the orifice required for the particular size skimmer. A minimum diameter of 1/2" orifice is recommended to avoid clogging.

### Cutting the Orifice

After determining the radius of the orifice use the tool provided to cut a hole in the plastic plug.

Measure the radius of the required orifice from the center of the pilot hole in the plug and mark it.

Loosen the bolt so it will slide in the slot; place the bolt in the pilot hole in the plastic plug; place the point of the nail on the mark for the orifice radius; **BE CAREFUL OF THE SHARP NAIL POINT!**

While holding in place, remove the bolt from the hole and tighten the nut and bolt.

Next, insert the bolt in the pilot hole in the flat side of the plastic plug until the nail point contacts the plastic.

Hold the plastic plug in one hand while turning the cutter with the other hand to scour the plastic. Don't try to cut through the plastic with just one turn, take several.

After scouring the flat side, remove the cutter, drive the nail slightly further through the plastic then scour the other side. The plastic should rest on the edges of the plug.

The plug should pop out after scouring both sides even if the plastic is not entirely cut through around the entire perimeter; if not completely cut, **carefully** use a knife to follow the scour line and finish cutting through the plastic.

Remove the screw eye on the strap and open the door on the skimmer.

Place the plug into the inlet that project through the side.

Don't glue the plug on; doing so limits the possibility of installing another orifice and reusing the skimmer in another basin.

The plug should fit tight enough to stay on, but tighten the screw slightly to hold it. After installing the skimmer check to make sure the plug has not fallen out while moving the skimmer.

If the plug is too tight to go in place, cut a notch from the center to the outside of the plug so it will contract slightly and go in place.

## Assembling and Installing the Skimmer

### Skimmer Assembly

Assemble as follows:

Insert the vent into the hole in the Tee with the long end pointing to the rear, the side with the door. Tighten the screw to secure it.

Glue the pipe with the coupling and screw into Tee on the skimmer so the screw points up.

Cut the barrel (not included, available at plumbing and hardware stores) 6' - 8' long, depending on the length needed to pull the skimmer to the side of the basin.

Prime only one end of the PVC pipe for the barrel and the female coupling on the flexible joint. Then glue the pipe to the coupling.

Without glue (so it can be disassembled later) slip the other end of the pipe (a little grease is recommended) into the bushing at the outlet end of the pipe on the skimmer. Secure the pipe by tightening the Phillips head screw so that the point goes slightly into the pipe.

## Installation

Install as follows:

Lay the assembled skimmer on the bottom of the basin with the flexible joint at the inlet of the pipe through the dam or at the connection with the riser.

Remove any dirt or mortar on the pipe and slip the 4" coupling over the pipe inlet. Tighten the two screws so the points just pierce the side of the pipe to secure the connection.

Position the skimmer over the excavated pit in the basin.

The skimmer should settle level across the top of the pipe with the door on it, so that the debris guards work. Otherwise, debris that accumulates around the float will flow under the float and clog the screen when the water level drops.

Adjust the flexible joint connection if necessary, especially if the skimmer is pulled to the side and the barrel is not aligned with the outlet pipe. The float is balanced so that the rear settles down as the last few inches of water drain from the basin. This positions the float and guards to contain floating debris on the outside of the float as the water level drops.

If the skimmer is not level debris can flow under the float and clog the screen and possibly the orifice.

Place a stake at the connection of the flexible joint so the backhoe operator will know the location when excavating accumulated sediment from under the skimmer and not damage it.

After installing the skimmer check to make sure the orifice has not fallen out while moving the skimmer.

## The Rope

Tie the rope provided around the Tee between the vent and the horizontal tube.

Since it is polypropylene rope, which is slippery, use a good knot that will not come loose.

Secure the other end to a stake on the dam or side of the basin.

Put tension on the rope so the skimmer will settle into the pit after the basin drains.

If you need to lengthen the rope use one that will float. Otherwise, it may sink, be covered by sediment, and act as an anchor to keep the skimmer from floating. (This is known this from sad experience.)

## Maintenance

**Warning!** The skimmer is made to withstand normal handling and the filling and draining of the sediment basin but it cannot withstand being yanked around with a backhoe. Use the rope to carefully, manually position the skimmer or move it out of the way of heavy equipment for excavation.

## Sediment Removal

Erosion control (temporary and permanent stabilization) and controlling runoff within the catchment is essential to prevent sediment generation, prevent pollution, and reduce basin maintenance. When the sediment storage in the basins fills maintenance is required to restore the treatment volume in order to maintain basin efficiency.

Sediment removal is needed before sediment accumulates up to the crest of the weir in the first baffle.

Excavate the sediment from the entire basin to restore the original sediment storage volume.

When sediment accumulates around the skimmer to the point it cannot settle low enough to drain the entire basin sediment removal is required.

Pull the skimmer to one side so the sediment underneath it can be excavated.

Excavate the entire cell formed by the baffle, not just around the skimmer.

### **Baffles**

Make repairs if damaged, the posts are laid over, water is flowing underneath, or the fabric has fallen. If water or sediment is escaping around the ends tie the ends into the side of the basin.

### **Skimmer**

**Trash** If the skimmer is clogged with trash and there is water in the basin, usually a few jerks on the rope to make the skimmer bob up and down will dislodge the debris and restore flow. If this does not work pull the skimmer over to the side (it's easiest to do when the basin is partially full) and remove the debris. Also check the orifice inside the skimmer to see if it is clogged; if so remove the debris.

**Sediment Under the Skimmer** If sediment accumulates to the point the skimmer cannot settle low enough to drain the entire basin pull the skimmer over to one side and excavate the sediment with a backhoe.

**Clogged barrel or pipe through the dam.** If the skimmer is clogged despite removing debris and it appears that either the barrel between the orifice and the flexible joint or the pipe through the dam is clogged take the following steps to clear the blockage (sediment will sometimes accumulate in the pipe).

Pull the skimmer over to the side.

Remove the pin and open the door to access the orifice.

Remove the orifice plug or cap.

Raise the inlet as high as practical.

Fill the barrel with water (use a bucket and funnel or a pump) to remove the clog using the water and pressure.

After the obstruction is removed continue pouring water into the barrel to flush out accumulated debris and sediment to prevent future clogging.

A plumbers snake can be used but flushing out the sediment and debris accumulation is recommended first.



## Appendix

### Components of an Effective Sediment Basin

#### Skimmers

The skimmer is complete except for the barrel and ready to assemble and attach to the 4" Sch 40 PVC pipe through the dam or a connection on the riser. The barrel is provided by the user and is a section of Sch 40 PVC pipe (solid, not foam core) of the appropriate diameter for the particular skimmer. It is readily available from plumbing suppliers or many hardware or building material outlets.

The barrel should be 6' - 8' long so the skimmer can be pulled to the side of the basin for maintenance. A longer barrel may be needed for deep basins so the angle of the barrel is no more than 45° when the basin fills.

#### The Basin

A hole in the ground does not create an effective sediment basin. The basin must be properly sized and shaped to maximize sedimentation. See Figure 2. The basin does not have to be shaped exactly like the illustration but incorporate the concepts.

Size the basin according to local erosion and sediment control standards. However, experience is that many standard design procedures do not create a large enough basin. The skimmer will not overcome the inefficiency of a basin that is too small for the size of the catchment and runoff characteristics, ignores the soils, slopes, and sediment generated. **Sizing the basin for only the disturbed area instead of the total catchment does not provide adequate treatment volume.** Ideally a basin would retain the volume of runoff generated for the majority of the storms expected from the entire catchment after development of the site. In Orange County, North Carolina that would be as much as 2.5" or 3" of rainfall. These are only general recommendations.

#### Sediment Storage

Where only part of the drainage area is to be disturbed sediment storage is not as critical as when the entire drainage area will be disturbed, the soil is highly erosive, and the slopes steep. Calculate the expected sediment generated for at least 6 months and provide that additional storage volume in the bottom of the basin. The treatment volume should be maintained by excavating accumulated sediment when the sediment storage volume is full. The skimmer is intended to drain the entire basin so that sediment will dry out for removal.

#### Surface Area

The basin should be shallow, just 3' for small basins and only 4' or 5' for the largest basins. A deep hole is an ineffective basin. Settling efficiency is improved by the shallow depth and sediment is kept away from the skimmer by the baffles.

#### Length to Width Ratio

The basin should be at least twice as long as wide with the inflow at one end and the skimmer and overflow at the opposite end for maximum efficiency. **Exception:** Making small basins long and narrow reduces the storage volume in the bottom of the basin because the side slopes form a V-shaped bottom with little storage capacity. Therefore small basins should be constructed square or slightly rectangular with the first baffle across the middle and the second placed halfway between the outlet and the first baffle.

#### Pit Under the Skimmer

Excavate a shallow pit under the skimmer to accommodate sediment that reaches the outlet end and settles around the skimmer. The pit allows the skimmer to settle to the bottom and drain the entire basin. The bottom of the pit should be below the invert of the outlet pipe the skimmer is attached to.

The pit usually holds a small amount of water that aids in keeping debris away from the skimmer that could clog the screen and inlet.

### Leveling the Skimmer

For the trash guards to work the skimmer must settle down level, as read across the top of the section of pipe with the door. The rear of the float settles down and the front rises so that trash does not flow under the bottom edge of the float.

### Turbid Outflow

Even with the improved sediment trapping efficiency discharge from the skimmer will still be turbid and a visible clouding will occur in clear receiving waters. Dispersing outflow from the skimmer into a wooded or vegetated buffer is recommended before it enters a watercourse to further clarify the water. If properly done this can be very effective.

### Ice

Place a prop or support under the skimmer to maintain a positive slope on the barrel so water does not stand in the barrel; otherwise the standing water will freeze and plug the barrel. Keeping the water moving should prevent it from freezing even through the surface of the basin may freeze over.

Use either a metal fence post (wood will float away) laid across the top of the pit, cinder blocks on the bottom, or a wooden support staked firmly in the ground.

**Note:** any of these devices will be destroyed if the pit is excavated, so the fence post may be the best choice; it could easily be removed and replaced.

Which ever method is used, adjust the elevation to provide a slight, positive slope on the barrel.

Erecting a vertical pole on the shore to hold the rope out of the water may prevent it freezing in the ice and rendered useless to retrieve the skimmer.

The following advice is based on limited experience with sediment ponds freezing over Orange County, North Carolina. Since the inlet is below the surface the skimmer should continue to drain unless the ice gets so thick it blocks the inlet. So far in Orange County the basins continued to drain and the ice was deformed into a large bowl but the ice was at most an inch thick.

## Basin Outlets

### Skimmer

Use a 4" Sch 40 PVC pipe (solid, not foam core) for connecting the skimmer. The large, solid pipe is used so it is not crushed or does not sag during installation and to maintain free flow of water. In addition, there may be some sediment accumulation in this pipe that would reduce its capacity. Refer to Figure 3.

### Spillway

Instead of conventional riprap, spillways shaped in the soil and lined with plastic tarps or wide geotextile fabric have been used for erosion resistant linings to reduce costs. When properly installed these spillways survived 9.5" of rain in 1996 during Hurricane Fran.

The tarp must be wide and long enough to cover the bottom and sides and extend onto the top of the dam for anchoring with spikes. The tarp must be long enough to extend down the slope and exit onto stable ground. The width of the tarp must be one piece, not joined or spliced; otherwise water can get under the fabric. However, the length can be spliced if done properly.

If the length of tarp available is insufficient for the entire length multiple tarps may be used; the upper end of the lower tarp must be anchored with spikes through the grommets; the lower edge of the upper tarp is lapped over the upper end of the lower section at least 18". Secure the upper edge of the tarp and the sides as shown in the illustrations. Refer to Figure 4 and 5.

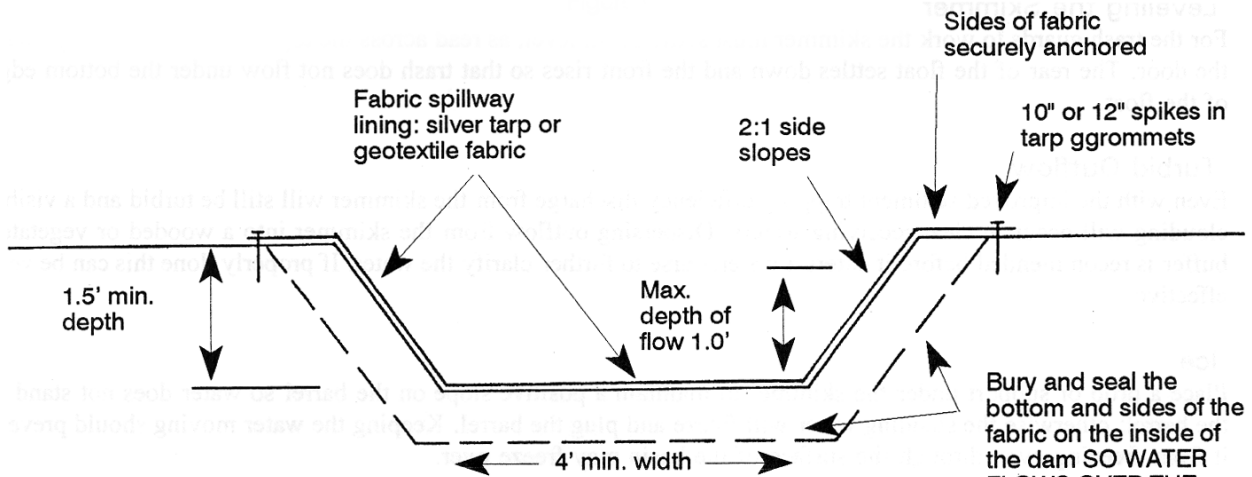

**NOTE ON FABRIC WIDTH AND LENGTH:** The **WIDTH** must cover the bottom and sides and lap onto the top of the dam in one continuous piece without splices. The **LENGTH** must extend to undisturbed ground below the dam but it can be spliced as shown below.

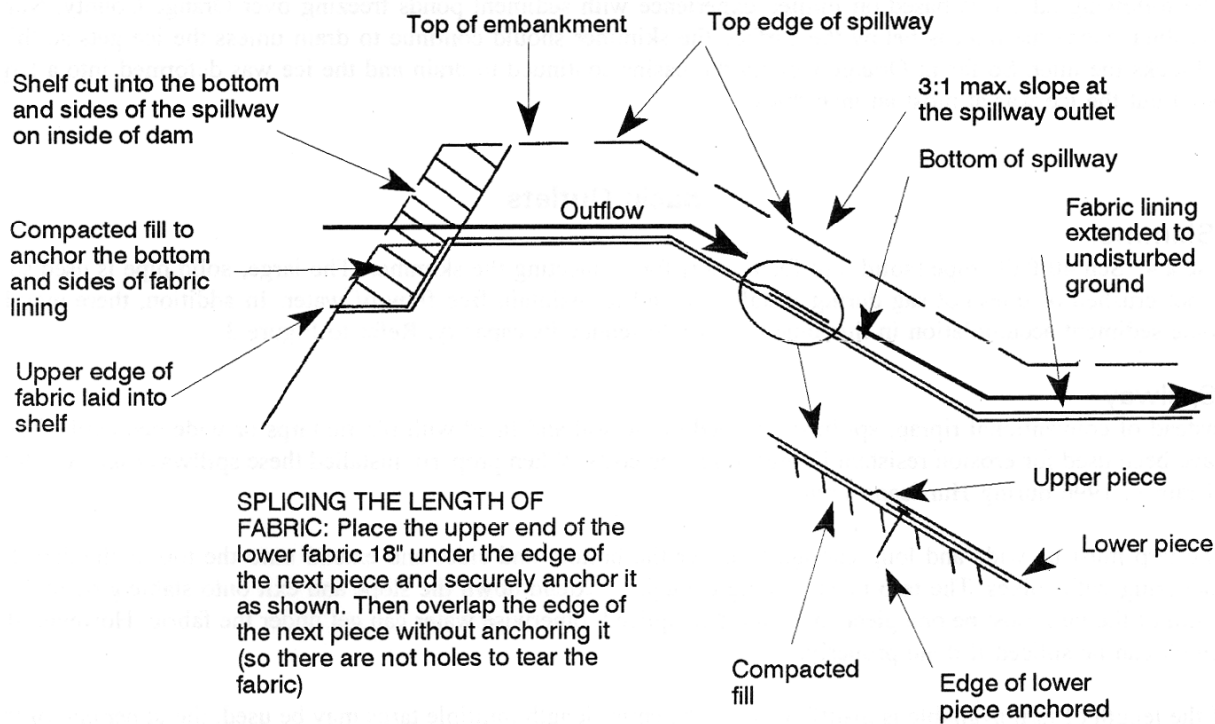

**SPLICING THE LENGTH OF FABRIC:** Place the upper end of the lower fabric 18" under the edge of the next piece and securely anchor it as shown. Then overlap the edge of the next piece without anchoring it (so there are not holes to tear the fabric)

This type of spillway can only be used where there is an appropriate location. Topography, property lines, and other factors may require the use of a riser and barrel even in basins with small catchments.

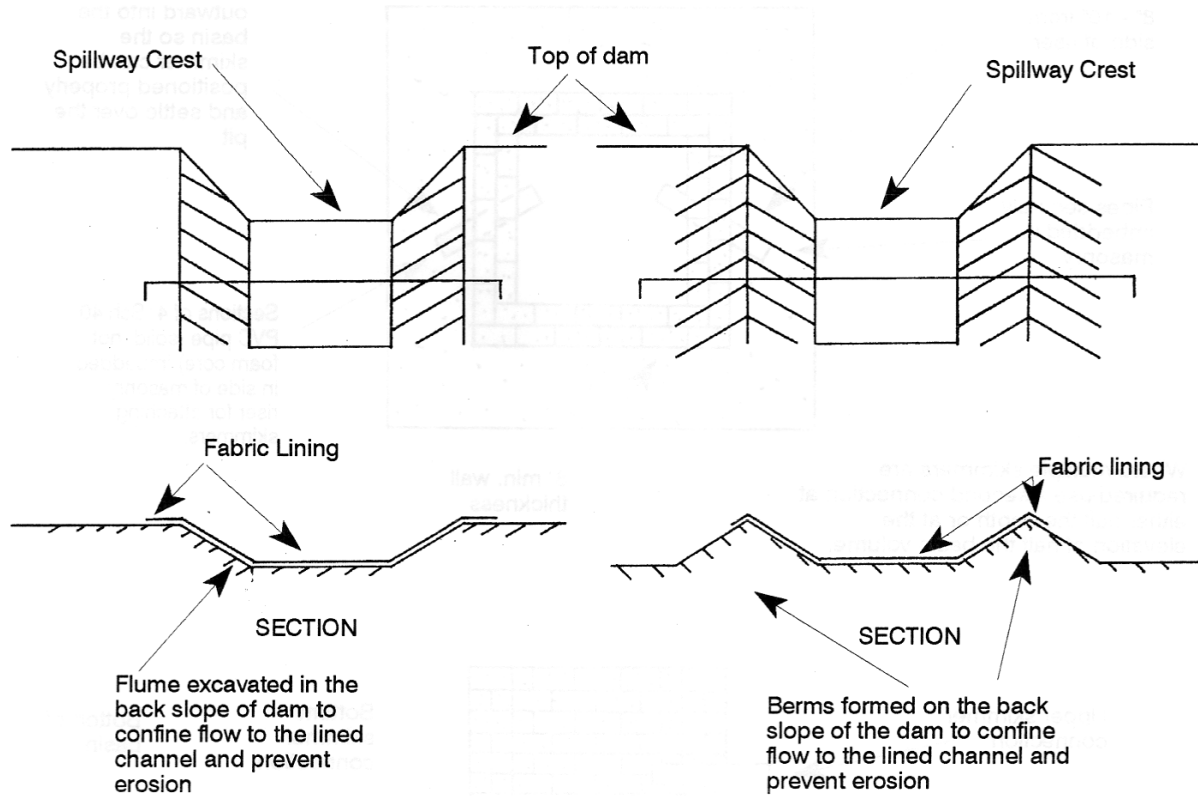

## Riser

Refer to the illustrations for the skimmer connections. Angle the stubouts as shown so the skimmer settles in the desired locations and not on top of each other or in the way of retrieving them. Refer to Figure 6.

When metal risers are used the stubouts of appropriate diameter will have to either be welded on or a single stubout can be attached at the bottom and fittings for additional skimmers, if required, fabricated out of PVC pipe.

## Connection of Skimmer to a Temporary Masonry Riser

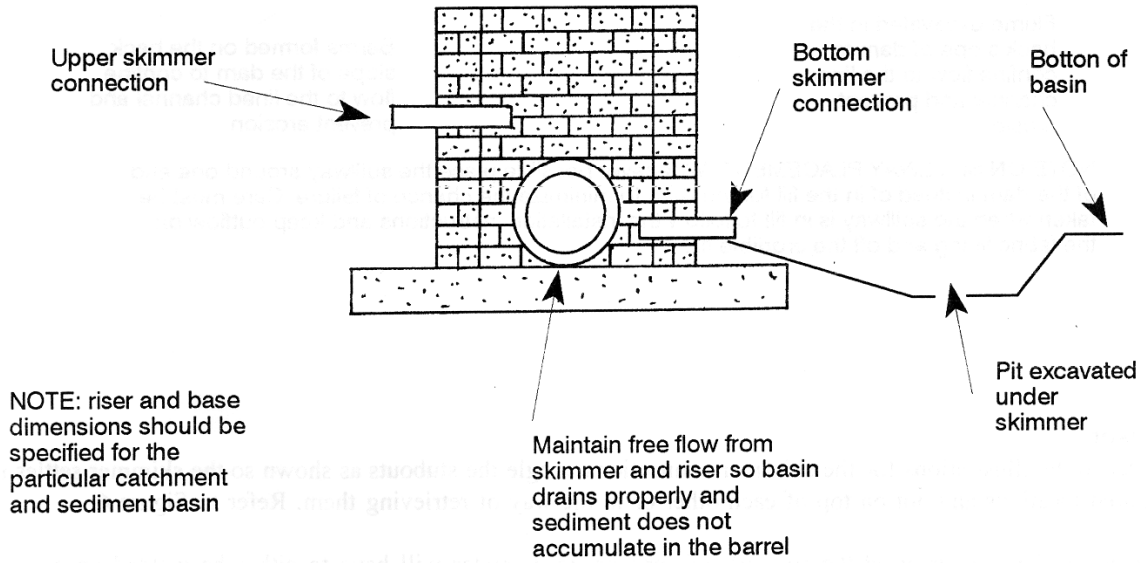
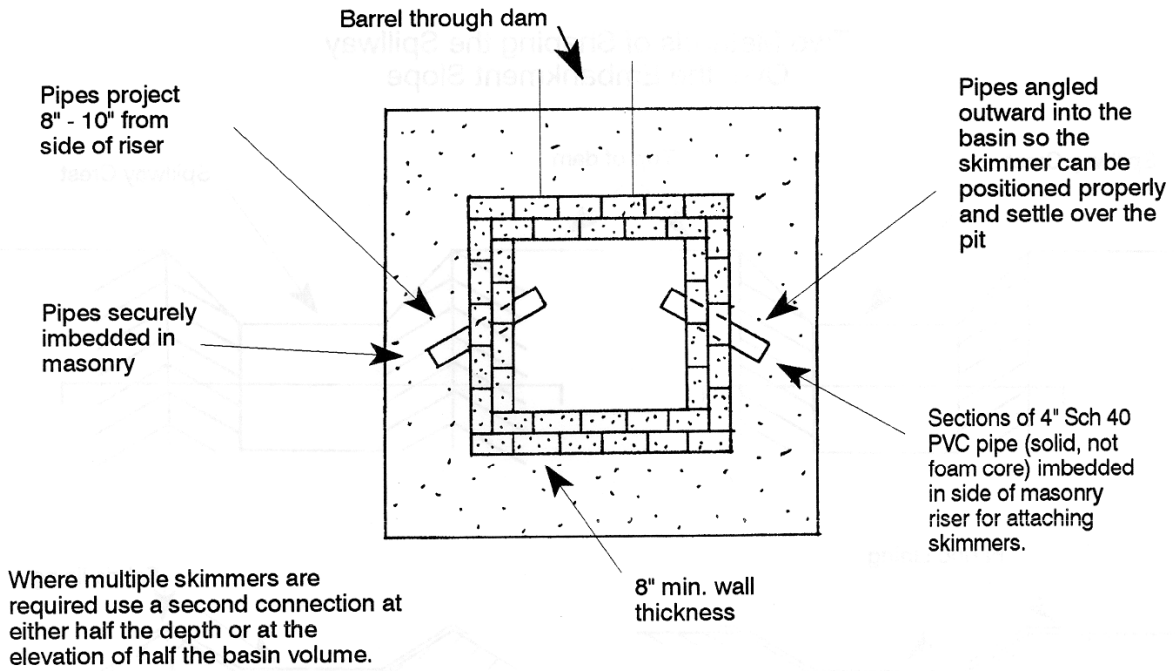

## **Baffles**

### **Purpose**

Baffles improve basin efficiency by containing sediment in the upper end of the basin and preventing its resuspension. This keeps sediment away from the skimmer so that it can settle to the bottom and completely drain the basin.

Silt fence baffles are not intended to filter sediment; it is just a convenient, inexpensive way to construct them. It is usually not feasible for the top of the baffle to reach the crest of the spillway due to the height limitations of silt fence.

Baffles are not optional even when a long narrow basin is used. Besides increasing efficiency baffles are needed to contain sediment in the upper end away from the skimmer and limit erosion and resuspension of accumulated sediment. Tie the ends into the side of the basin; otherwise sediment flows around the ends and short circuiting results.

### **Construction**

Curve the baffles as shown in the illustrations and use wire reinforcing at the top of the stakes to strengthen them.

Use woven geotextile fabric in the baffles so that water trapped in the accumulated sediment can drain out toward the skimmer and the sediment can dry out for removal. Non-woven fabric clogs too easily and traps water in the sediment.

When rock in the basin prevents driving the fence posts to the required depth and shifting the locations slightly does not work, it will be necessary to drill holes for the posts. Where a single post cannot be driven to the required depth the reinforcing wire at the top of the posts may provide enough support. Again, baffles are not an option. Other alternatives are to use riprap or other large rocks to form dams 18" to 24" high that would serve as baffles. Use stone or geotextile fabric on the upstream side. This is probably an expensive option.

### **Baffle Placement for Clean Out**

When installing the baffles imagine where a backhoe could sit to excavate accumulated sediment and make adjustments to the baffle locations and orientation. Use common sense and locate the baffles so the backhoe can reach along and in between the baffles instead of over them.

For baffle construction refer to Figure 7.

# Silt Fence Baffle Construction

## Step #1

Layout baffle location and dig a 6" x 6" trench along the bottom and sides of the basin. Drive steel fence posts 18" into the ground and place the post no more than 4' apart.

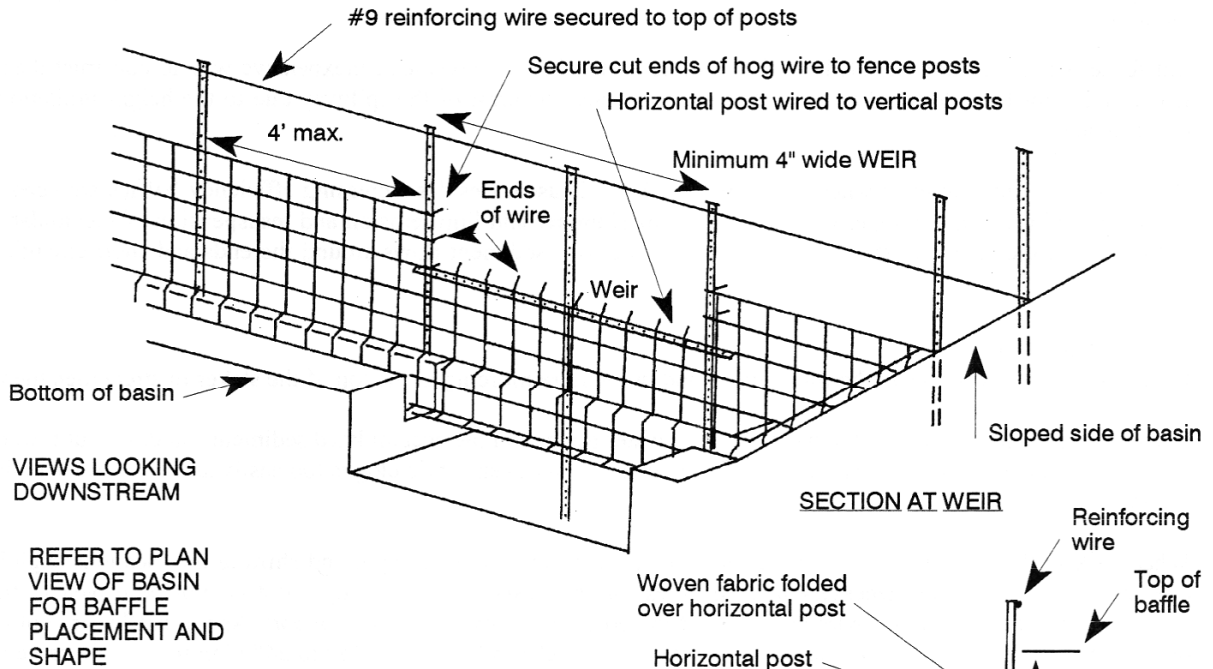

## Step #2

Attach woven fabric on upstream side of baffle. Secure fabric to hog wire and posts with staples.

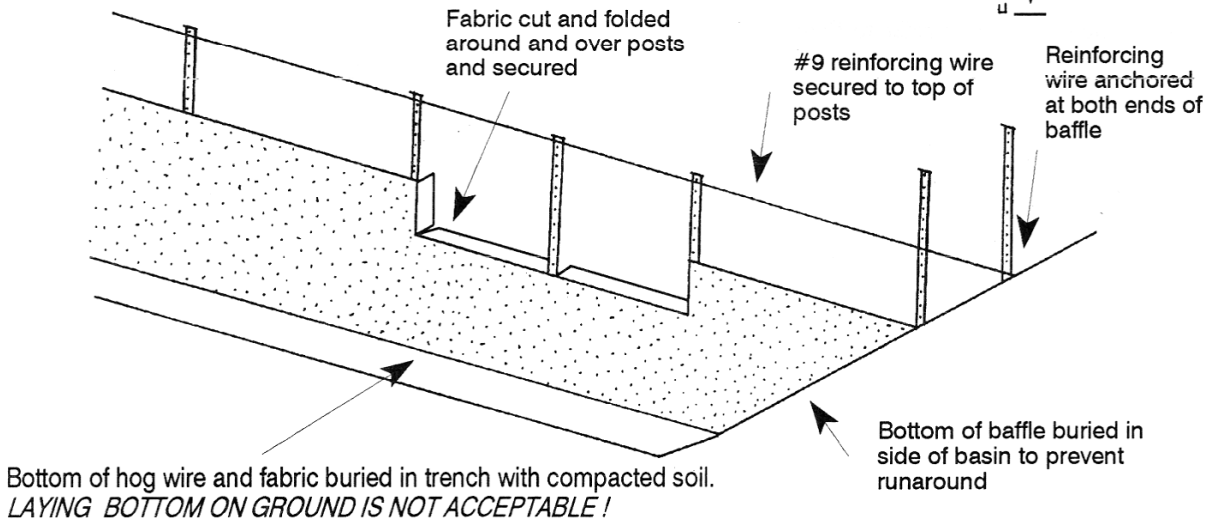
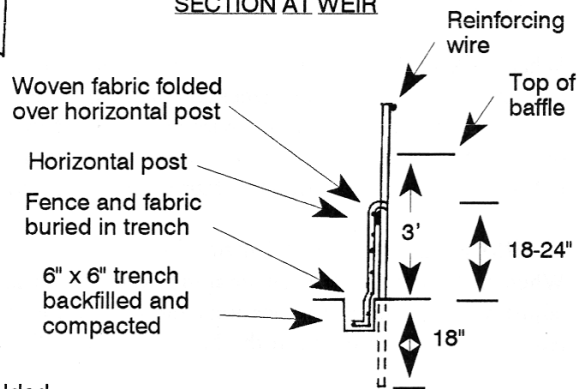

## Potential Problems and Solutions

### Trash and Debris On the Screen or Orifice

**Prevention:** The measures described above will minimize but not totally prevent trash accumulation on the screen in all cases. The amount of trash from a particular disturbance varies.

**Solution:** If trash accumulates, when the basin has water in it, usually a few strong tugs on the rope will bounce the skimmer up and down enough to dislodge the debris and restore flow. If the orifice is clogged it may be necessary to pull the skimmer to the side, open the door to remove the debris (or insert a thin stick through the screen to clear it), and launch the skimmer to finish draining the basin.

### Sediment Accumulating Around the Skimmer

**Prevention:** The basin's shallow depth and long, length together with the baffles and inflow into the upper end, are intended to keep sediment away from the skimmer.

**Solutions:** Regular excavation to maintain the sediment storage volume in the upper end of the basin will reduce the problem. When sediment does restrict skimmer movement, pull the skimmer to one side and remove the accumulated sediment as described above.

### Ice

**Prevention:** Provide positive drainage on the skimmer barrel and pipe through the dam as described above.

**Solutions:** If it becomes clogged with ice pull the skimmer to the side to expose it to warmer air and sunlight to thaw the barrel.

### UV Radiation

**Prevention:** The plastic used in the skimmer is tough under most uses for a couple of years.

**Solution:** In coastal locations where sunlight is more intense protection may be needed using a sheet of plywood. See Solution under Vandalism.

### Vandalism

**Prevention:** As much as possible (taking other considerations into account) position the skimmer out in the basin as far as possible from the banks to increase the range of projectiles and thereby decreasing the potential for a successful hit. Do not provide projectiles (loose stones and construction exits are a convenient source) close to the skimmer if avoidable. Experience is that the few skimmers damaged to date were located close to the dam with several feet of elevation between the launching point and the skimmer that increased the impact. Heavy duty pipe and fittings are used in the skimmer to minimize damage.

**Solutions:** Use the rope to position the skimmer away from the dam or any embankments. Where vandalism is anticipated (usually when there is residential neighborhood nearby) or it recurs use a sheet of 1/2" exterior plywood as a cover over the skimmer to absorb the impacts. Make it about four inches larger than the float and cut out an elongated hole for the vent (so movement is not restricted) to protrude through. Secure the cover to the float. If necessary remove the end rope from the dam so that the skimmer cannot be retrieved except by authorized personnel.

### Basin Drains Too Slow or Too Fast

**Prevention:** If the basin volume used to size the orifice is incorrect the basin will drain too fast to too slow. During the winter the catchment to some basins (particularly wooded catchments) have a significant flow of water from springs that can prevent draining.



**Solutions:** Adjustments may be needed to the flow rate; this can be done by cutting another orifice either slightly smaller or larger to adjust the rate of draining as described above under Altering Flow through the Orifice.

### Emergency Draining

**Reason:** The basin must be drained quickly for repairs or other reasons.

**Solution:** Removing the orifice and/or placing an end cap over vent will greatly increase the flow rate (double or triple depending on the slope of the barrel) or increase the size of the orifice as described above to increase flow.